

F60CW(V1) Series

60W single output with constant current circuit and PFC function



- **Constant current design(C.C. mode)**
- **Built-in PFC function** ● **Wide input range**
- **Protections:**
 - Over voltage /Short circuit
- **IP68 design for outdoor installations**
- **100% full load burn-in test**
- **Suitable for LED lighting and moving sign applications**
- **Safety standards :**
EN61347-1, EN61347-2-13/J61347-1, J61347-2-13/K61347-1, K61347-2-13
- **EMC standards :**
J55015/K00015, K61547, K61000-4-2, 3, 4, 5, 6, 11
- **Metal case** ● **5years warranty**

IP68 SELV LPS CB CE

ITEM		UPF60S24CW(V1)	UPF60S36CW(V1)	UPF60S48CW(V1)
INPUT	VOLTAGE RANGE	AC90~264V		
	FREQUENCY RANGE	47~63Hz		
	POWER FACTOR	PF>0.9 at over 60% of rated power		
	EFFICIENCY(typ.)	87%	88%	88%
	AC CURRENT(typ.)	0.6A/115VAC (typ) 0.3A/230VAC (typ)		
	INRUSH CURRENT(typ.)	COLD START 40A/230VAC		
	LEAKAGE CURRENT	<2.5mA / 230VAC		
OUTPUT	RATED CURRENT	2.5A	1.66A	1.25A
	OPERATING VOLT. RANGE	18-24V	27-36V	36-48V
	RATED POWER	60W	60W	60W
	CURRENT ADJ. RANGE	Fixed. Can be modified between -30~+10% rated output current(But do not use over rated power)		
	CURRENT ACCURACY	±5%	±5%	±5%
	RIPPLE&NOISE(max.) Note2	290mVp-p	410mVp-p	530mVp-p
	SETUP,RISE TIME(max.)	3000ms,100ms/115VAC at full load 3000ms,100ms/230VAC at full load		
	HOLD UP TIME(typ.)	50ms/115VAC at full load 50ms/230VAC at full load		
PROTEC-TION	SHORT CIRCUIT	Hiccup mode ; recovers automatically after fault condition is removed		
	OVER VOLTAGE	115~140% of rating		
ISOLA-TION	WITHSTAND VOLTAGE	I/P-O/P:AC3.75KV, I/P-F.G:AC1.88KV, O/P-F.G:AC0.5KV		
	ISOLATION RESISTANCE	I/P-O/P, I/P-F.G, O/P-F.G:DC500V 100Mohms(At room temp. & humid.)		
ENVIRON-MENT	WORKING TEMP.&HUMID.	-30~+70℃ (Refer to "DERATING CURVE),20~95%RH		
	STORAGE TEMP.&HUMID.	-40~+80℃,10~95%RH		
	VIBRATION	10~500Hz, 5G 12min./1cycle, period for 72min. each along X, Y, Z axes		
OTHERS	DIMENSION	189*73*52.8mm(L*W*H)		
	PACKING	0.95Kg		

NOTE

1. All parameters not specially mentioned are measured at 220vac input, rared load and 25℃ of ambient temperature.
2. Ripple & noise are measured at 20MHz of bandwidth by using a 12" twisted pare-wire terminated with 0.1 uF & 47uF parallel capacitor.

S.M.P.S

LED Converter

Water Proof Converter

■ BLOCK DIAGRAM

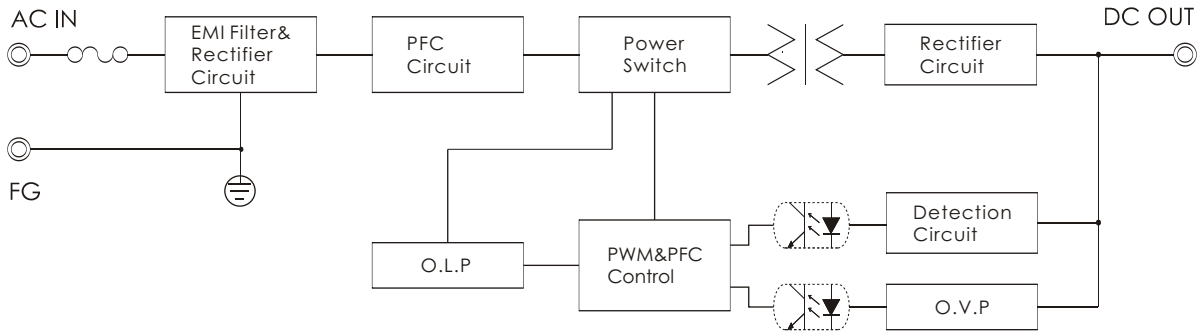

■ DIMENSIONS(unit:mm)

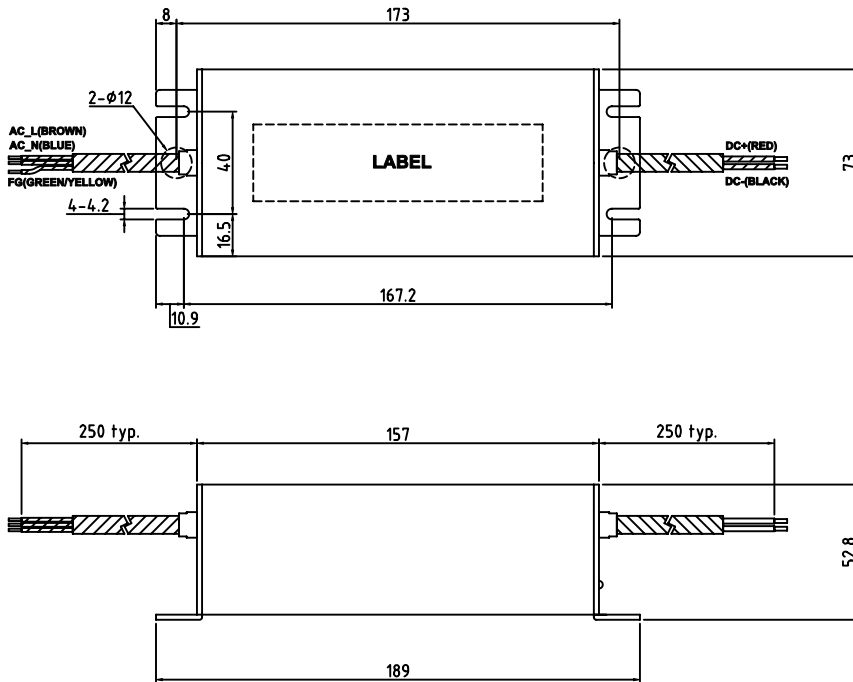

■ DERATING CURVE

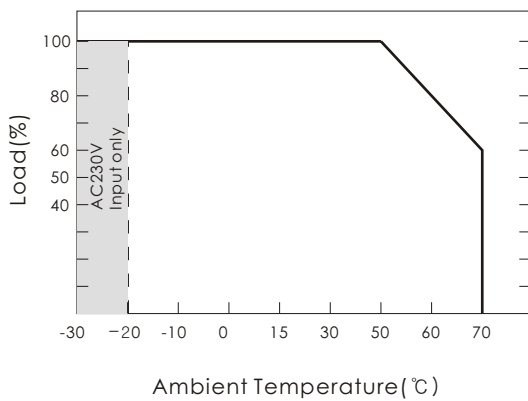

■ STATIC CHARACTERISTICS

