

Approval Sheet for SMD LED

Reference No : T3528FL-432
Version No : Rev 0.0
Customer Name : STANDARD
Model Name : LFMFL-ER15
Color : Cool White Color
Issued Date : 14 October. 2014

Customer

Customer					

CTL

CTL					
Eng'ring	Develop.	Prod.	QA	Sales	Approved

Remarks:



358-1. Sin-Dong, Yungtong-Gu, Suwon-Si, Gyeonggi-Do, 442-390
http://www.ctlinc.com **Tel : (031) 205-0450., Fax : (031) 205-5315**

1. Features and Applications

- Package : SMD Package
- Resin : Diffused type
- Dimensions in mm : 3.5 x 2.8 x0.7 (L x W x H)
- Technology : InGaN Blue Chip + Phosphor
- Viewing Angle : wide (120°)
- Assembly methods : suitable for all SMT assembly methods
- Soldering methods : IR reflow soldering
- Preconditioning : acc. to JEDEC Level 3
- MSL : Qualified according to JEDEC moisture sensitivity Level 3.
- Taping : 12mm conductive black carrier tape & antistatic clear cover tape
3,000pcs/reel, Φ180mm wheel

Applications:

- Outdoor displays
- Backlighting (LCD, switches, keys, displays, illuminated advertising, general lighting)
- Interior automotive lighting (e.g. dashboard backlighting, etc.)
- Indicator

2. Part Name Description

L F M FL - ER 15

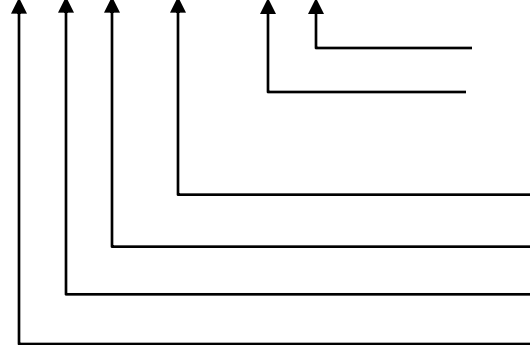

15 : **Rev. No.**

ER : **Code No.**

FL : Flash White color.

M : **3.5mm x 2.8mm** Series

F : Lead **F**rame Type SMD LED

L : LED

3. Outline Dimensions and Materials

1) Outline Dimensions

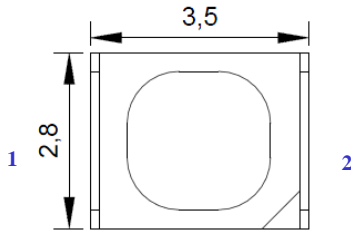

TOP

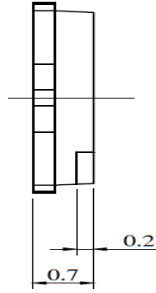

SIDE

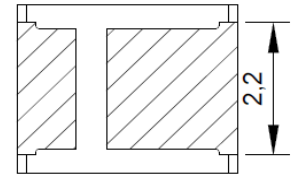

BOTTOM

- MODEL : LFMFL
- TYPE : 3.5 x 2.8 x 0.7(t)
- TOLERANCE : ± 0.15mm

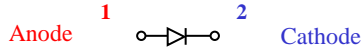

Circuit Diagram

2) Materials

- Encapsulant : Silicone Resin , Clear (Optional : Diffuser type)
- Paste : Epoxy
- Electrode : Ag Plating

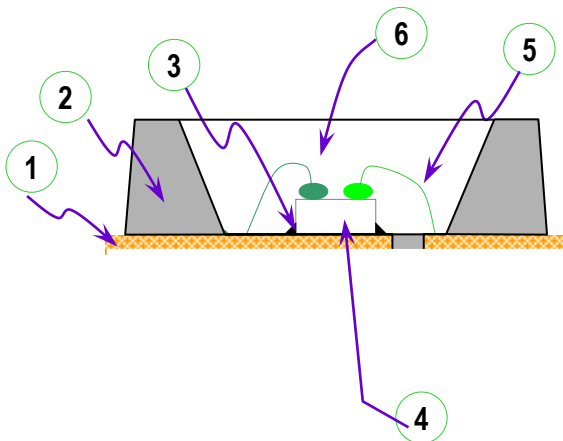

Number	Item	Material
1	Lead	Cu / Ag
2	Pre Mold	PPA
3	Paste	Epoxy
4	LED Chip	InGaN / Al ₂ O ₃
5	Wire	Gold Wire
6	Encapsulant	Silicone

4. Specifications

1) Absolute Maximum Ratings

Items	Symbol	Maximum Rating	Unit
Forward Current	I_F	150	mA
Pulse Forward Current*	I_{FP}	213	mA
Power Dissipation	P_D	525	mW
Reverse Voltage	V_R	5	V
Junction Temperature	T_j	110	°C
Thermal Resistance Junction to Soldering	$R\theta_{j-S}$	19	°C/W
Operating Temperature	T_{opr}	-30 ~ 85	°C
Storage Temperature	T_{stg}	- 40 ~ 100	°C

$T_c = 25\text{ °C}$

I_{FP} Conditions : Pulse Width ≤ 0.1 msec. And Duty $\leq 1/10$

2) Initial Electrical / Optical Characteristics

Items	Symbol	Min.	Typ.	Max.	Unit	Condition
Forward Voltage	V_F	2.9	-	3.5	V	$I_F = 150\text{ mA}$
Luminous Flux	Φ_v	45	-	54.5	mcd	$I_F = 150\text{ mA}$
Reverse Current	I_R	-	-	10	uA	$V_R = 5\text{ V}$
Chromaticity Coordinates	C_x	-	0.30	-	-	$I_F = 150\text{ mA}$
	C_y	-	0.31	-	-	
General color rendering index	R_a	70	-	80		$I_F = 150\text{ mA}$
Viewing Angle	2θ1/2	-	120	-	Deg.	$I_F = 150\text{ mA}$

Luminous Intensity Measuring Equipment : LX4560A (Teknologue, JAPAN)

Voltages are tested at a current pulse duration 1ms and an accuracy of $\pm 0.1\text{ V}$

Luminous Intensity is tested at a current pulse duration 5ms and an accuracy of $\pm 10\%$

Dominant Wavelength is tested at a current pulse duration 5ms and an accuracy of $\pm 1\text{ nm}$

5. Grouping parameter

1) Chromaticity Coordinates Ranks

(Tc = 25 °C)

Bin Code	X	Y
CW 1	0.3029	0.2809
	0.2979	0.2966
	0.3078	0.3068
	0.3115	0.2894
CW 2	0.2979	0.2966
	0.2924	0.3133
	0.3039	0.3256
	0.3078	0.3068
CW 3	0.2962	0.2739
	0.2901	0.2882
	0.2979	0.2966
	0.3029	0.2809
CW 4	0.2901	0.2882
	0.2837	0.3034
	0.2924	0.3133
	0.2979	0.2966
CW 5	0.2910	0.2682
	0.2842	0.2814
	0.2901	0.2882
	0.2962	0.2739
CW 6	0.2842	0.2814
	0.2770	0.2955
	0.2837	0.3034
	0.2901	0.2882
CW 7	0.2836	0.2597
	0.2759	0.2715
	0.2842	0.2814
	0.2910	0.2682
CW 8	0.2759	0.2715
	0.2676	0.2839
	0.2770	0.2955
	0.2842	0.2814

Bin Code	X	Y
CW 9	0.2767	0.2515
	0.2682	0.2619
	0.2759	0.2715
	0.2836	0.2597
CW 10	0.2682	0.2619
	0.2592	0.2729
	0.2676	0.2839
	0.2759	0.2715
CW 11	0.2704	0.2436
	0.2612	0.2529
	0.2682	0.2619
	0.2767	0.2515
CW 12	0.2612	0.2529
	0.2516	0.2627
	0.2592	0.2729
	0.2682	0.2619
CW 13	0.2647	0.2362
	0.2551	0.2445
	0.2612	0.2529
	0.2704	0.2436
CW 14	0.2551	0.2445
	0.2450	0.2553
	0.2516	0.2627
	0.2612	0.2529
CW 15	0.2597	0.2294
	0.2497	0.2371
	0.2551	0.2445
	0.2647	0.2362
CW 16	0.2497	0.2371
	0.2393	0.2450
	0.2450	0.2533
	0.2551	0.2445

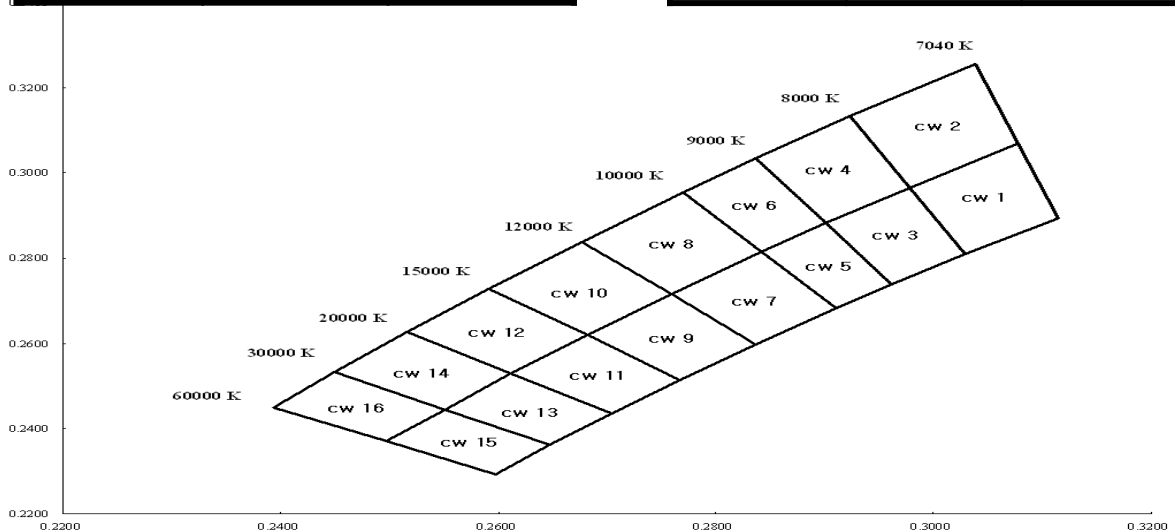

0.01 tolerance for Color Coordinates may be caused by measurement inaccuracy.

5. Grouping parameter(Continue)

2) Forward Voltage

(Tc = 25 °C)

V _F Rank	Min	Typ	Max	Unit	Test Condition
A	2.9	-	3.0	V	I _F = 150 mA
B	3.0	-	3.1		
C	3.1	-	3.2		
D	3.2	-	3.3		

Voltages are tested at a current pulse duration 1ms and an accuracy of ±0.1V

3) Luminous Intensity Ranks

(Tc = 25 °C)

Φ _v Rank	Min	Typ	Max	Unit	Test Condition
1	45	-	49.5	lm	I _F = 150 mA
2	49.5	-	54.5		

Luminous Intensity is tested at a current pulse duration 5ms and an accuracy of ±10%

6. Rank table

Rank	VF(V)	$\Phi_v(\text{lm})$	Chromaticity Coordinates
1	2.9 – 3.0	45 – 49.5	CW1 & CW2
2	2.9 – 3.0	45 – 49.5	CW3 & CW4
3	3.0 – 3.1	45 – 49.5	CW1 & CW2
4	3.0 – 3.1	45 – 49.5	CW3 & CW4
5	3.1 – 3.2	45 – 49.5	CW1 & CW2
6	3.1 – 3.2	45 – 49.5	CW3 & CW4
7	3.2 – 3.3	45 – 49.5	CW1 & CW2
8	3.2 - 3.3	45 – 49.5	CW3 & CW4
9	2.9 – 3.0	49.5 – 54.5	CW1 & CW2
10	2.9 – 3.0	49.5 – 54.5	CW3 & CW4
11	3.0 – 3.1	49.5 – 54.5	CW1 & CW2
12	3.0 – 3.1	49.5 – 54.5	CW3 & CW4
13	3.1 – 3.2	49.5 – 54.5	CW1 & CW2
14	3.1 – 3.2	49.5 – 54.5	CW3 & CW4
15	3.2 – 3.3	49.5 – 54.5	CW1 & CW2
16	3.2 - 3.3	49.5 – 54.5	CW3 & CW4

7. Typical Characteristic Curve

Fig.1 Maximum forward current vs. Ambient temperature

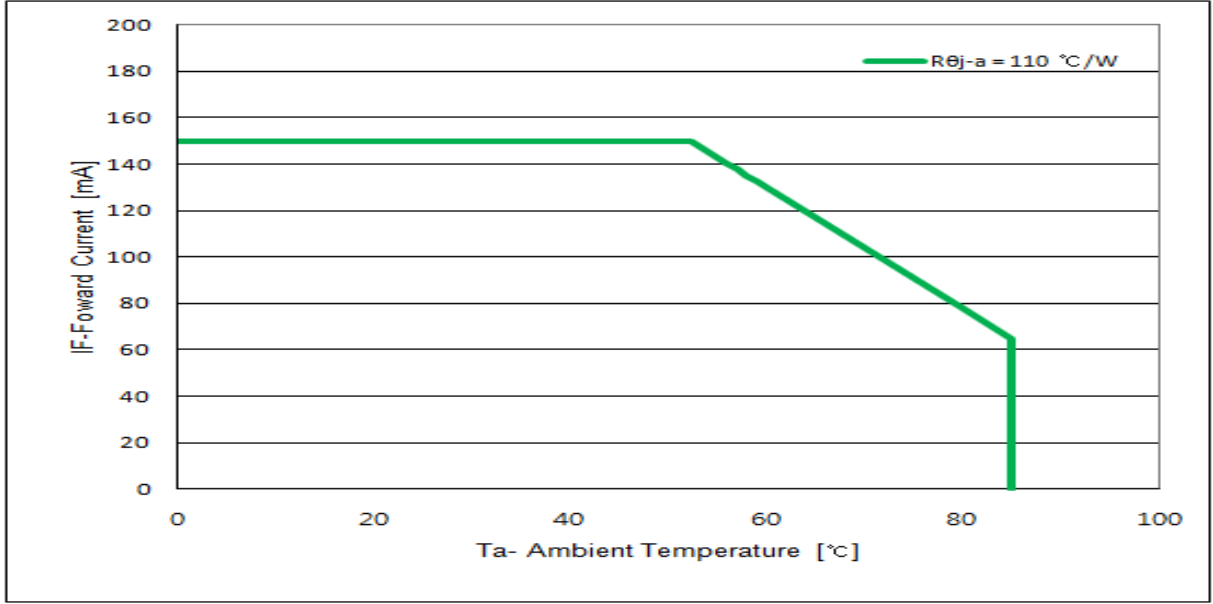
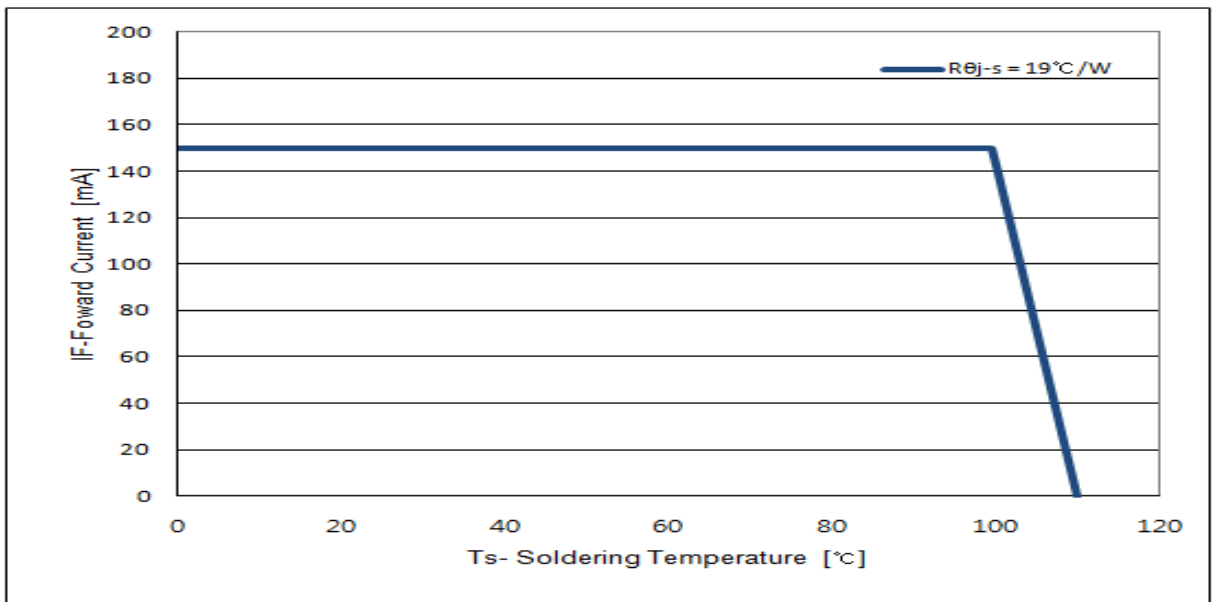

Fig.2 Maximum forward current vs. Soldering temperature



7. Typical Characteristic Curve (Continue)

Fig.3 Forward current vs. Luminous Intensity

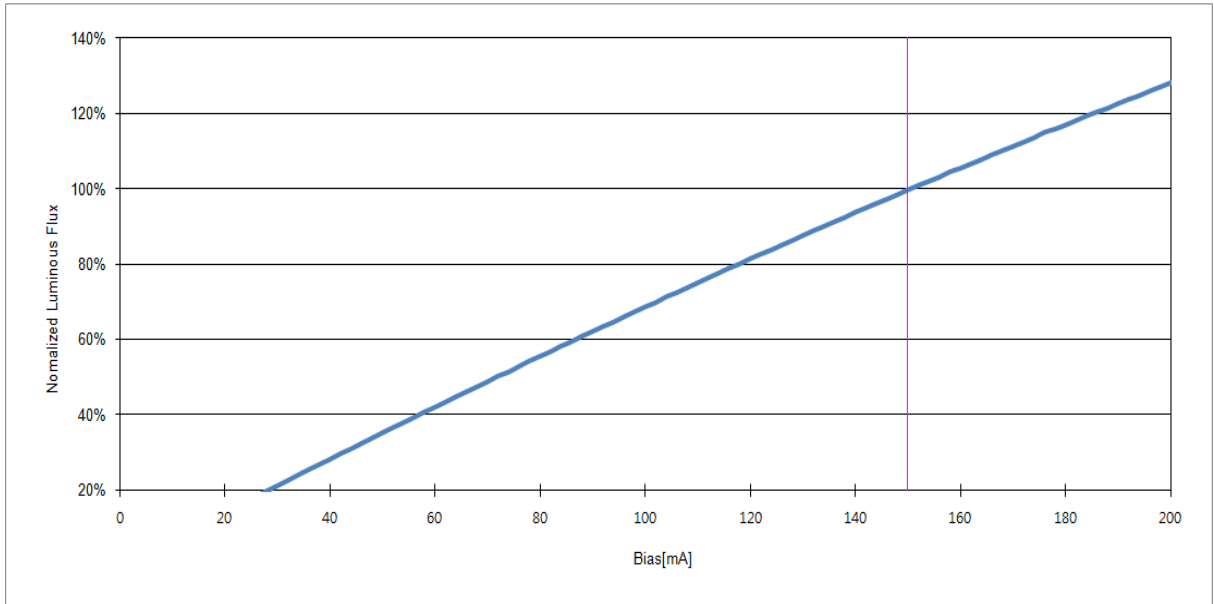
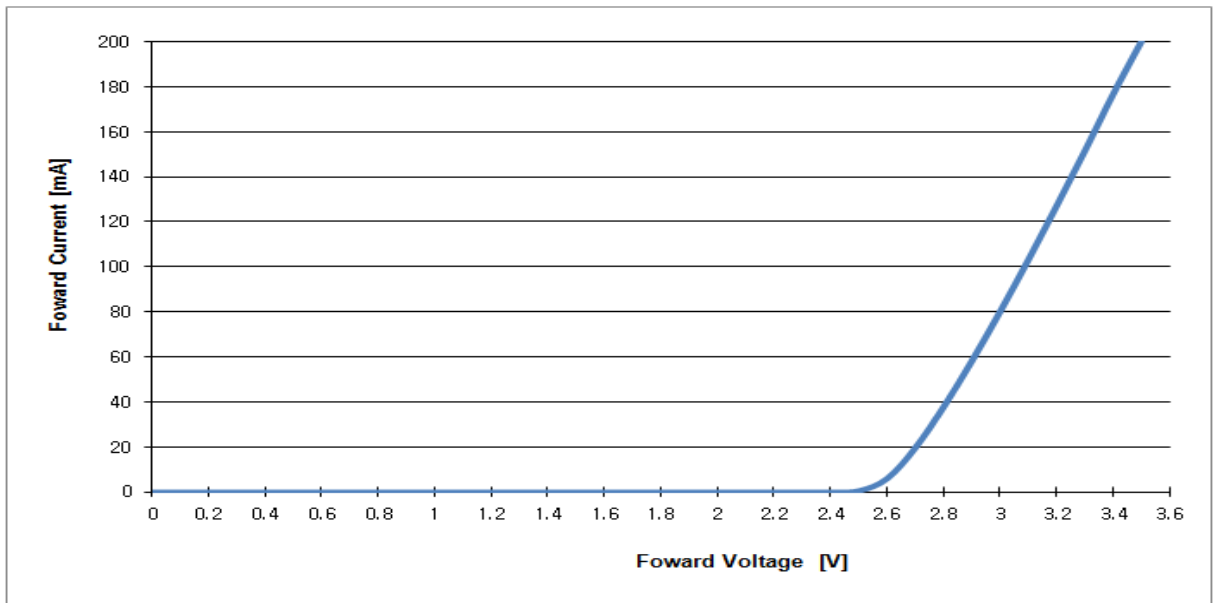

Fig.4 Forward voltage vs. Forward current



7. Typical Characteristic Curve(Continue)

Fig.5 Forward current vs Color Shift

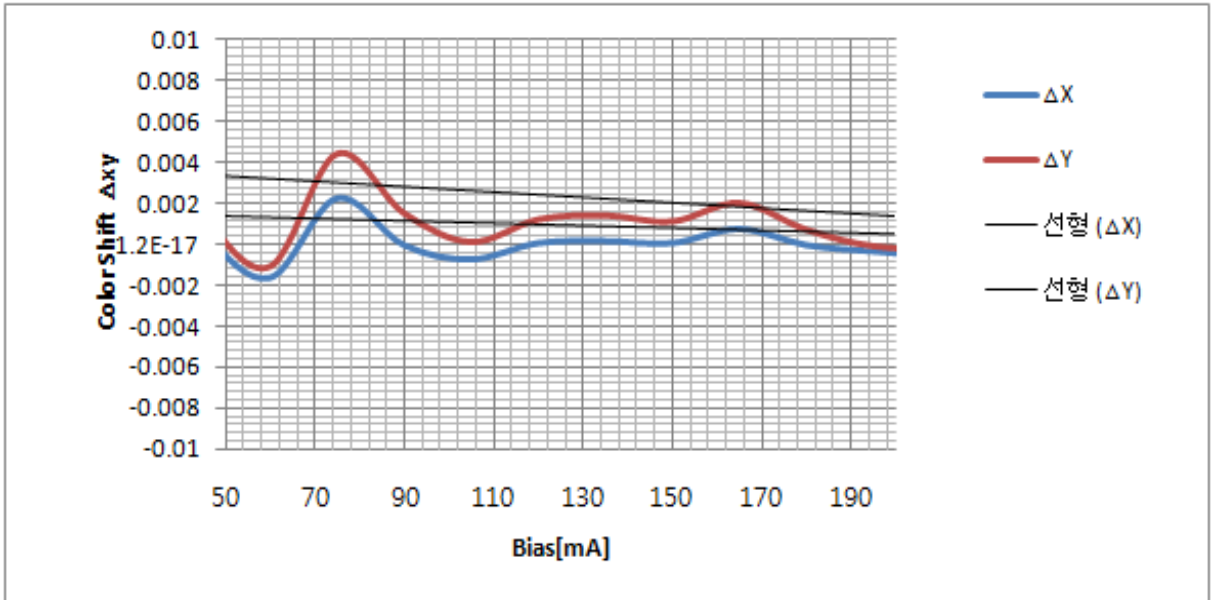
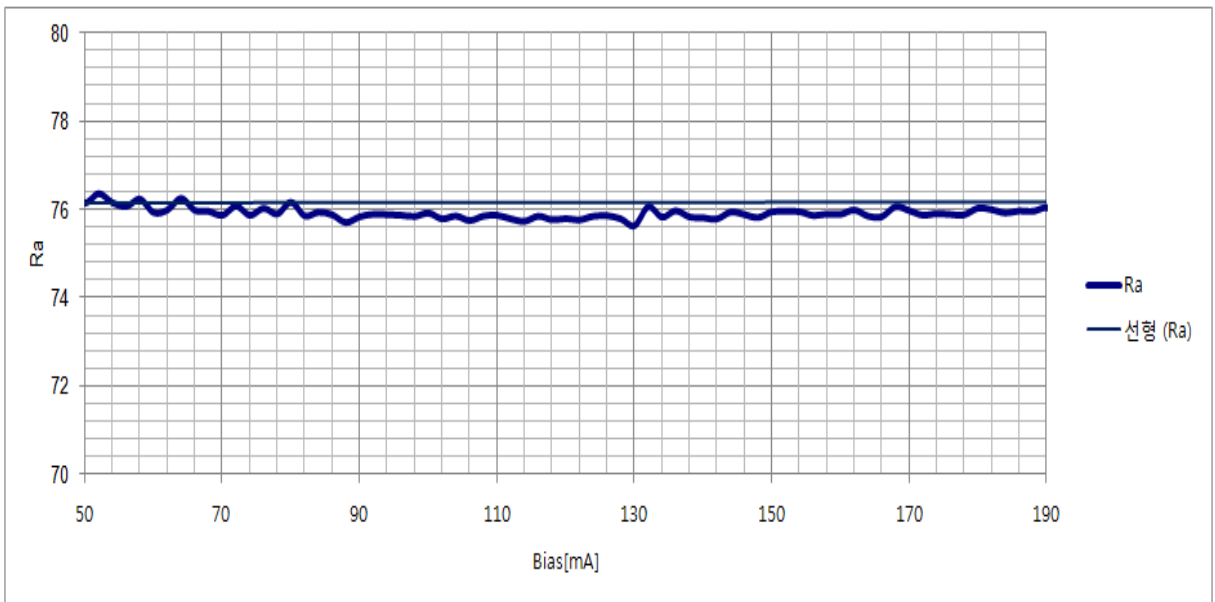

Fig.6 Forward current vs Color Rendering Index



7. Typical Characteristic Curve(Continue)

Fig. 7 Wavelength Distribution

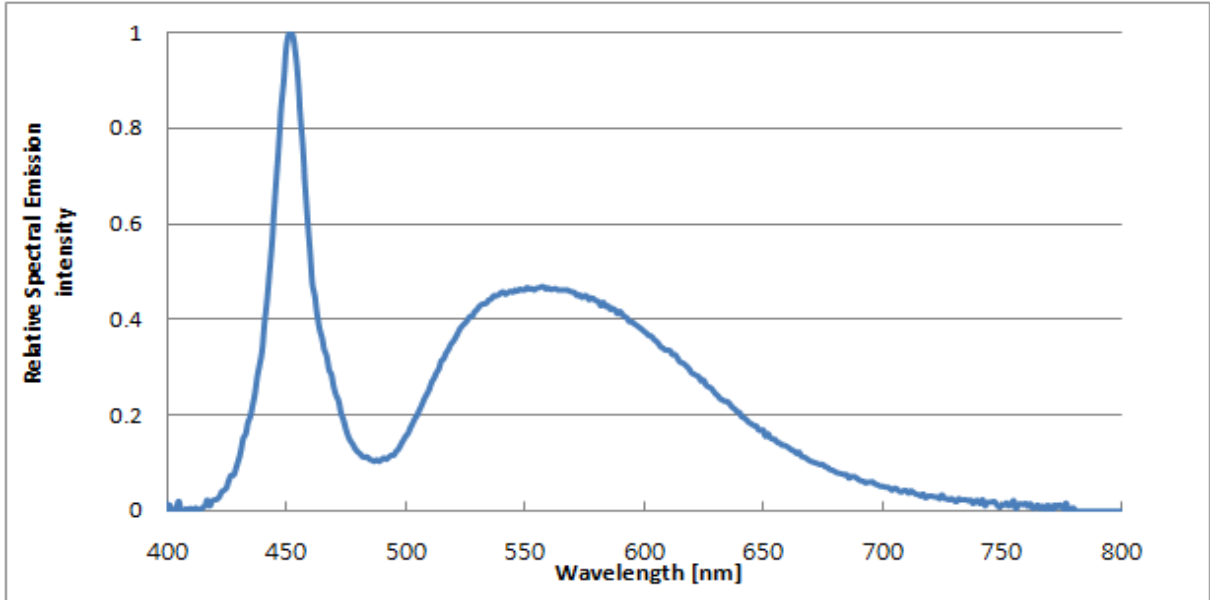
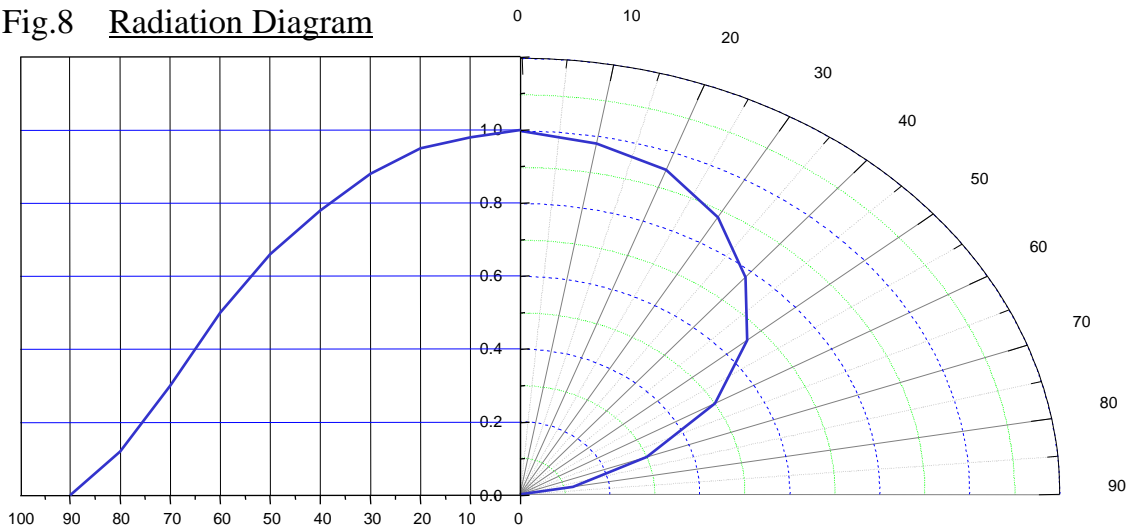

Fig.8 Radiation Diagram



8. Soldering Conditions

Reflow soldering is recommended, and soldering should not be done more than two times. When repairing is done, a double-headed soldering iron should be used.

1) SnPb Eutectic Solder Re-flow Profile (JEDEC J-STD-020C).

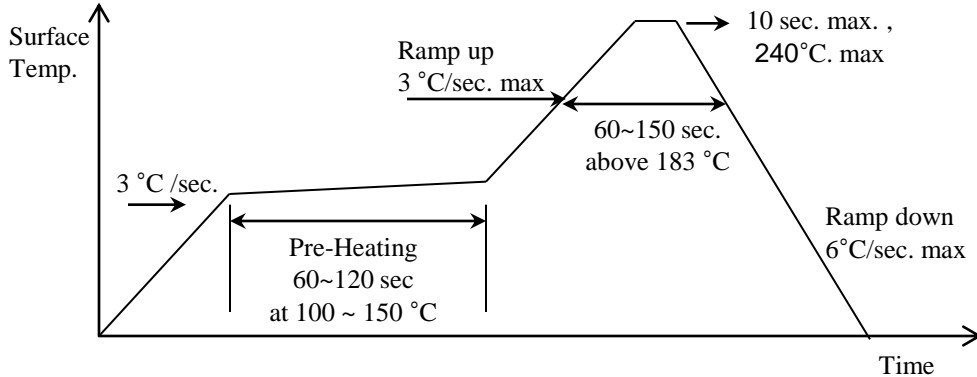

2) Lead-free Solder Re-flow Profile (JEDEC J-STD-020C).

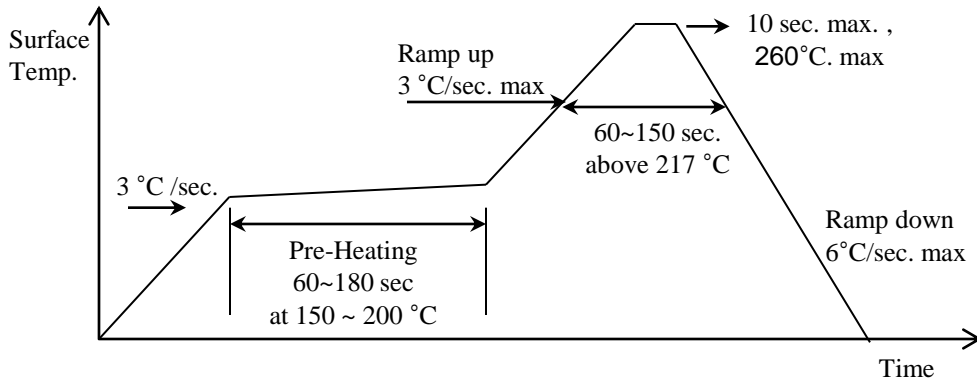

3) Solder Dip Profile

The Immersion of leads into a solder bath @MAX260 °C shall be to 5 seconds max.

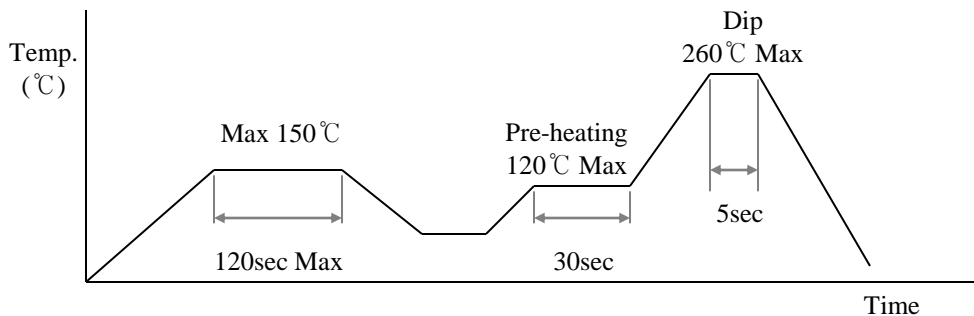

4) Double Wave Soldering Profile

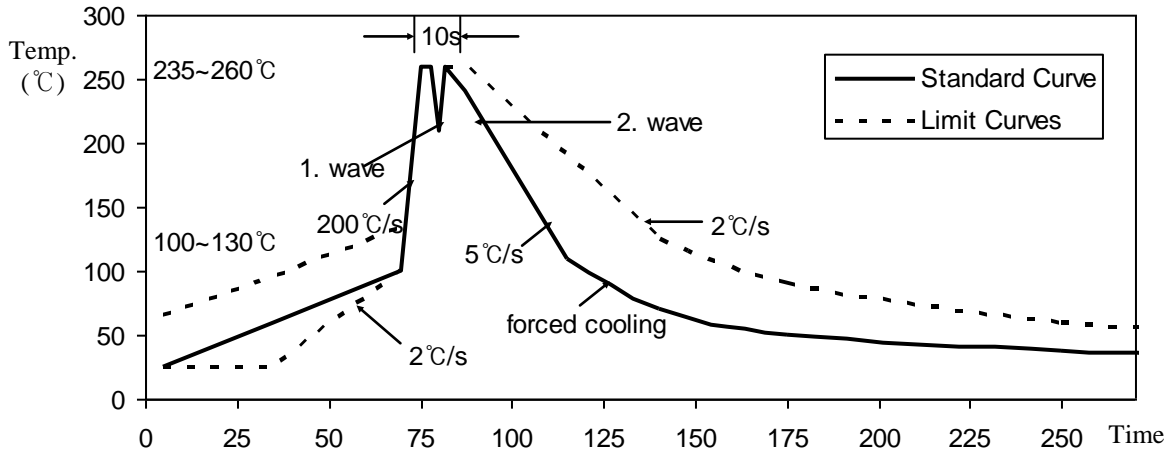

5) For manual solder

Not more than 5sec @max 300°C, under soldering iron.

6) Precaution for the Mounting

Do not apply force to the plastic part of the LED under high-temperature conditions.
 To avoid damaging the LED plastic, do not apply friction using hard materials.
 During installing the PCB in product, ensure that the device does not come into contact with other components

7) Recommended Operating Current

Operating current is optimized on test conditions of grouping parameter.
 We recommend the operating current of each LED more than 2mA.
 If the LED must be operated less than 2mA, special care should be taken to insure that the intensity of illumination is not ununiformed by deviation of the I_F upon low operating voltage.

8) Recommended Pad Lay out

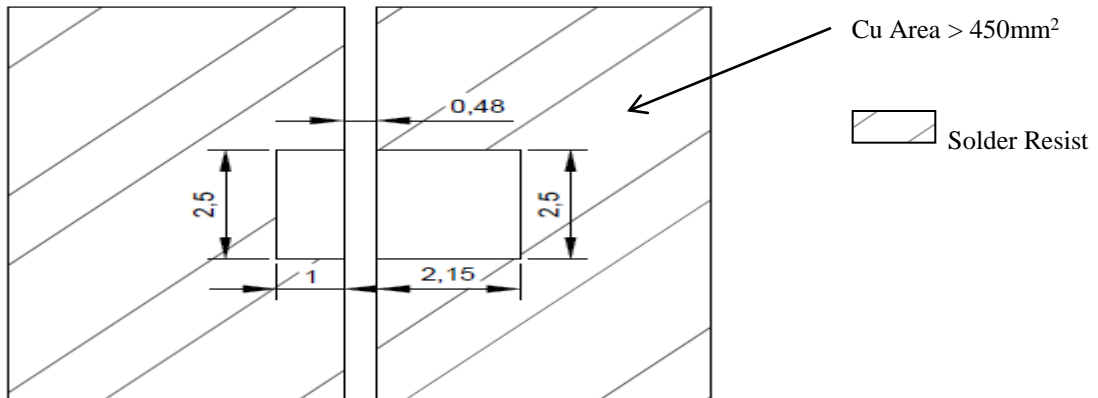

9. Packing Process and Materials

1) Dimension of tape (Material : PS Conductive, 10E4~5Ω)

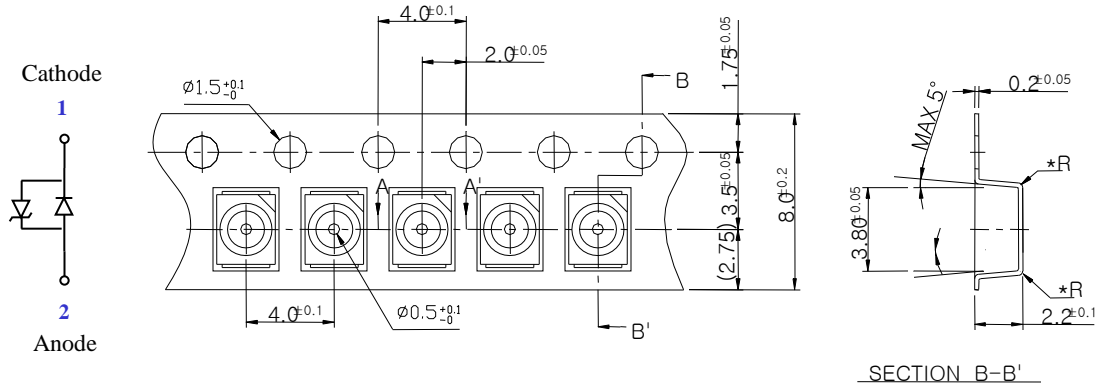

2) Details of Chip LEDs loading on tape

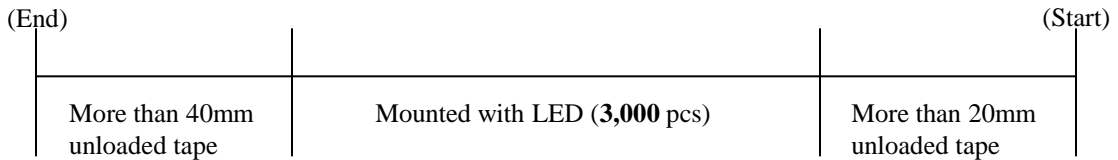

3) Dimension of Reel (Material : PS Conductive, 10E9~12Ω)

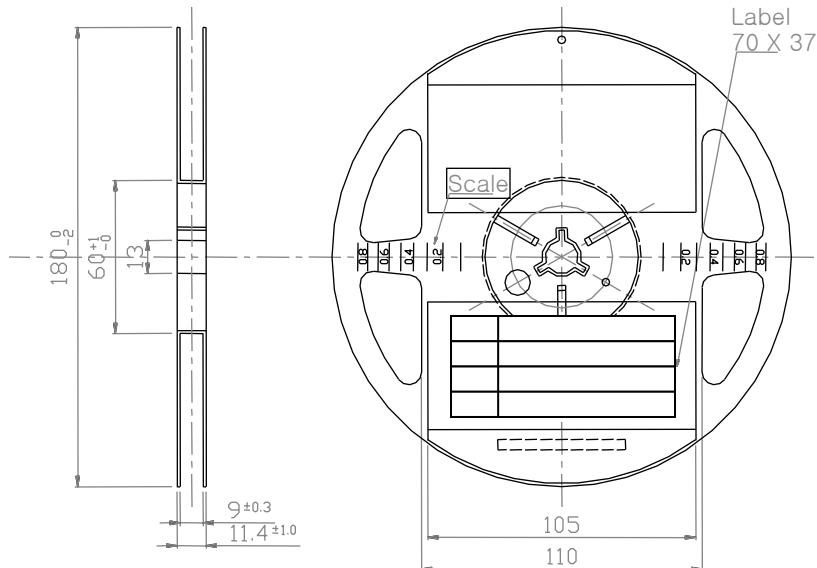

- (1) Quantity : Product are packed in one taping reel of max. **3,000** pcs.
- (2) Cumulative Tolerance : Cumulative Tolerance/10 pitches to be ± 0.2 mm
- (3) Adhesion Strength of Cover Tape : Adhesion strength to be 0.1-0.7N when the cover tape is turned off from the carrier tape at 10° angle to be the carrier tape.
- (4) Packaging : P/N, Manufacturing data Code No. and quantity to be indicated on a damp proof Package.

3) Packing Structure

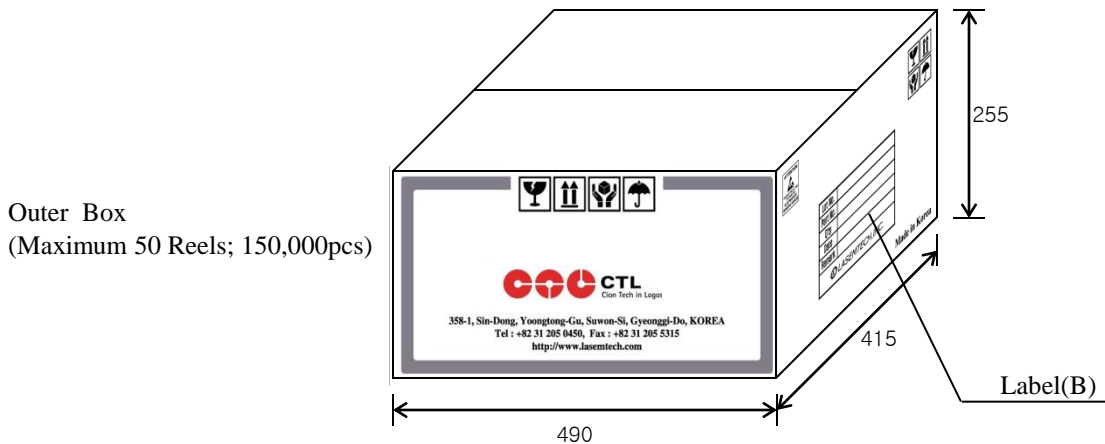
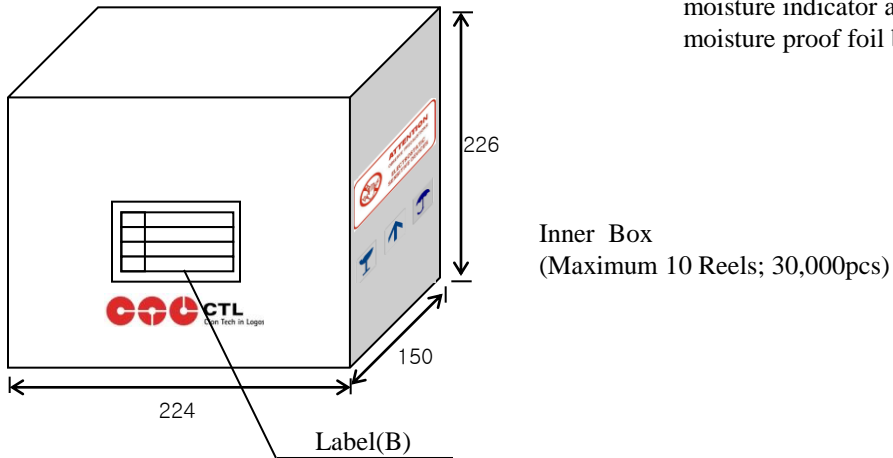
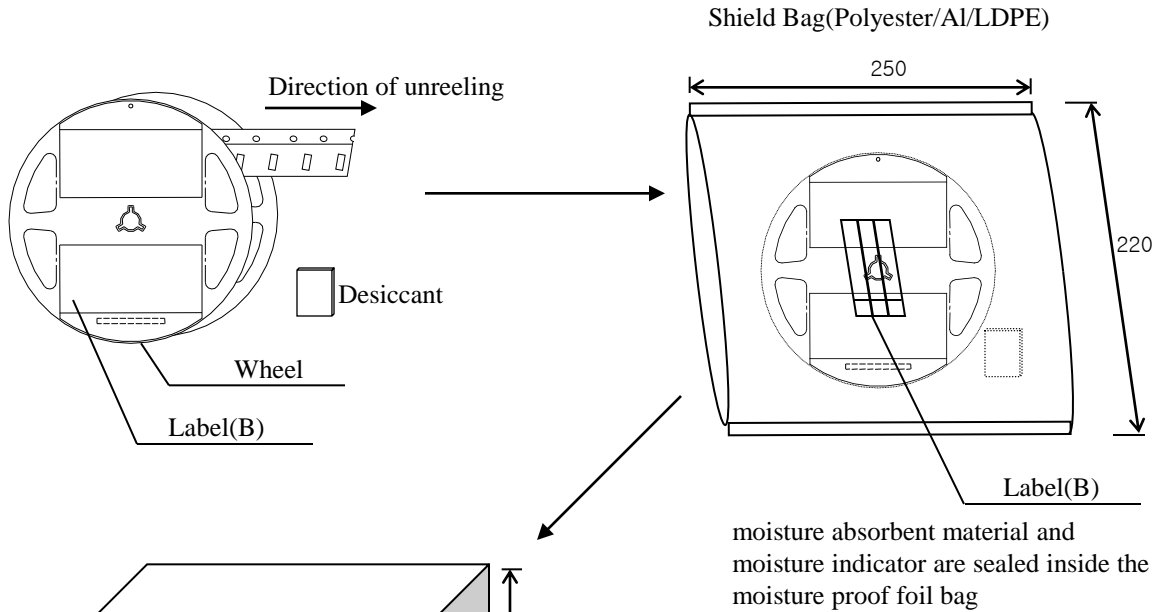

Spec No.	Ver.	Date	Page
T3528FL-432	0.0	2014/10/14	16 / 19

4) Labeling (ex> LFPFL-DR6x)

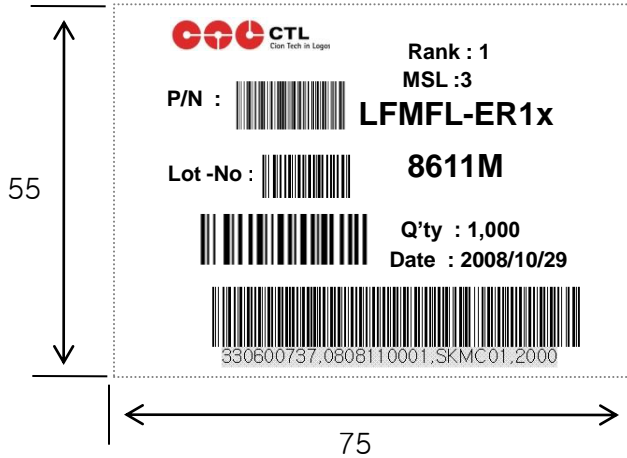

- Electrical/Optical Rank
- Product Code (Bar Code)
- Lot No (Bar Code)
- Reel Serial No
- Quantity (Bar Code)
- Packing Date(Bar Code)
- Customer Special (Bar Code)

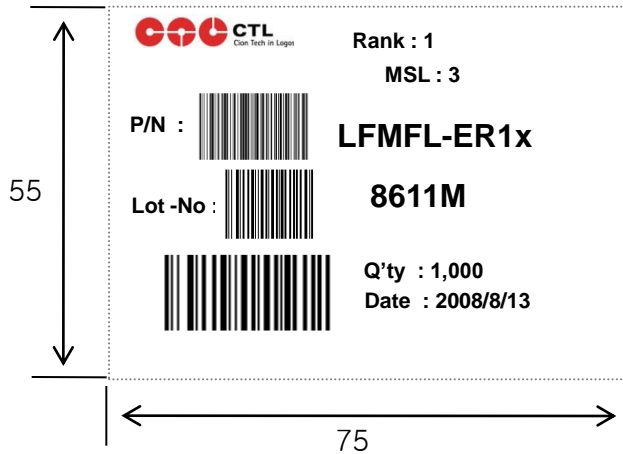

- Electrical/Optical Rank
- Product Code (Bar Code)
- Lot No (Bar Code)
- Reel Serial No
- Quantity (Bar Code)
- Packing Date(Bar Code)

10. Reliability

1) The reliability Criteria of SMD LED

Items	Symbol	Test Conditions	Criteria for Judgement	
			Min.	Max.
Forward Voltage	V_F	$I_F=65\text{mA}$	-	$\text{U.S.L.}^*) \times 1.1$
Luminous Intensity	I_V	$I_F=65\text{mA}$	$\text{L.S.L.}^{**}) \times 0.7$	-

□ *) U.S.L. : Upper Standard Level

***) L.S.L. : Lower Standard Level

2) Results of reliability test

Test Items	Reference	Test Conditions	Note
High Temperature Storage	JEITA ED-4701 200 201	100 °C / 1,000 hr.	0/32
Low Temperature Storage	JEITA ED-4701 200 202	-40 °C / 1,000 hr.	0/32
Temp. Humidity Storage	JEITA ED-4701 100 103	60 °C / 90 % RH / 1,000 hr.	0/32
Steady State Operating Life	EIA/JESD 22- A108-B	25 °C / 150 mA / 1,000 hr.	0/32
High Temperature Operating Life	EIA/JESD 22- A108-B.	85 °C / 65 mA / 1,000 hr.	0/32
Low Temperature Operating Life	EIA/JESD 22- A108-B.	-30 °C / 150 mA / 1,000 hr.	0/32
Steady State Operating life of High Humidity Heat	JEITA ED-4701 100 102	60 °C / 90 % RH / 130 mA 1,000 hr.	0/32
Temperature Cycle	JEITA ED-4701 100 105	-40°C(30min) → 25(5min.) → 100(30min.) / 100 cycle	0/22

11. Precaution for use

- This device should not be used in any type of fluid such as water, oil, organic solvent, etc.
When washing is required, IPA should be used.
- When the LEDs are illuminating, operating current should be decided after considering the ambient maximum temperature.
- In order to avoid the absorption of moisture, it is recommended to less 12 month store at 40°C , 90%RH or below environment
- After opening the moisture proof packing, the LED's should be kept at 5°C~30°C , 60%RH or below. The LEDs must be soldered within seven days(168 hours) after opening the moisture-proof packing.
If the LEDs remains after soldering , it should be stored into moisture proof container.
- Repack unused Products with anti-moisture packing, fold to close any opening and then store in a dry place.
- If upon opening, the moisture indicator card shows humidity 30% or above (Color of indication changes to pink) or the expiration date has passed, the device should be baked in taping with reel using the conditions of $65 \pm 5^\circ\text{C}$, 12~24hours.
After baking, use the baked devices within 72hours, but perform baking only once.
- Repeated baking can cause the peeling strength of the taping to change, then leads to trouble in mounting. Furthermore, prevent the devices from being destructed against static electricity for baking of it.
- The appearance and specifications of the product may be modified for improvement without notice.
- If the packing material of laminate would be broken, the hermeticity would deteriorate. Therefore. do not throw or drop the packed devices..
- This LEDs is sensitive to the electrostatic and surge,
It is recommended to use a wrist band or anti-electrostatic glove when handling the LEDs.
- If over-voltage which exceeds the absolute maximum rating is applied to LEDs, It will cause damage LEDs and result in destruction.
- Damaged LEDs will show unusual characteristics such as leak current remarkably increase, turn-on voltage becomes lower and the LEDs get unlight at low current.
- It is better not to use different rank LEDs.
If use mixed rank, could not attain your object for highest quality of products.

Spec No.	Ver.	Date	Page
T3528FL-432	0.0	2014/10/14	19 / 19

12. Revision history sheet

Spec No.	T5050FL-432		
Title	Approval Sheet for SMD LED		
Rev. No	Date	Summary of Revision	Remarks
0	2014.10.14	Initiate Document	