

## 8 PIN SOP PHOTOTRANSISTOR DUAL CHANNEL PHOTOCOUPLER

ELD20X / 21X series

### Features

- Dual channel coupler
- Current transfer ratios offered in narrow ranges
  - ELD205: 40-80%
  - ELD206: 63-125%
  - ELD207: 100-200%
  - ELD211: > 20%
  - ELD213: > 100%
  - ELD217: > 100%
- High isolation voltage between input and output  
Viso = 3750 Vrms
- Operating temperature range of -55 to +110°C
- High BVceo of 80V
- Standard SO-8 footprint package
- Pb free and RoHS compliant.
- UL approved (No. E214129)
- VDE approval (pending)
- SEMKO approved
- NEMKO approved
- DEMKO approved
- FIMKO approved
- CSA approved (No. 2007189)

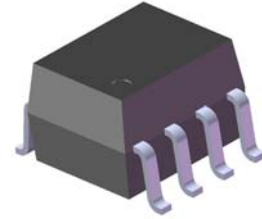

### Schematic

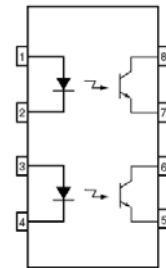

1. Anode
2. Cathode
3. Anode
4. Cathode
5. Emitter
6. Collector
7. Emitter
8. Collector

### Description

The ELD20X and ELD21X series contains two infrared emitting diodes optically coupled to two phototransistor detectors.

The devices are packaged in an 8-pin small outline package which conforms to the standard SO-8 footprint.

### Applications

- Feedback Control Circuits
- Interfacing and coupling systems of different potentials and impedances
- General Purpose Switching Circuits
- Monitor and Detection Circuits



LIGHTING FOREVER

# 8 PIN SOP PHOTOTRANSISTOR DUAL CHANNEL PHOTOCOUPLER

## ELD20X / 21X series

### Absolute Maximum Ratings (T<sub>a</sub>=25°C)

Parameter		Symbol	Rating	Unit
Input	Forward current	I <sub>F</sub>	60	mA
	Peak forward current (t = 100μs)	I <sub>FM</sub>	1	A
	Reverse voltage	V <sub>R</sub>	6	V
	Power dissipation No derating needed	P <sub>D</sub>	90	mW
Output	Collector power dissipation No derating needed	P <sub>C</sub>	150	mW
	Collector-Emitter voltage	V <sub>CEO</sub>	80	V
	Collector-Base voltage	V <sub>CBO</sub>	80	V
	Emitter-Collector voltage	V <sub>ECO</sub>	7	V
Total power dissipation		P <sub>tot</sub>	250	mW
Isolation voltage *1		V <sub>iso</sub>	3750	V <sub>rms</sub>
Operating temperature		T <sub>opr</sub>	-55~+110	°C
Storage temperature		T <sub>stg</sub>	-55~+150	°C
Soldering temperature *2		T <sub>sol</sub>	260	°C

#### Notes

\*1 AC for 1 minute, R.H.= 40 ~ 60% R.H. In this test, pins 1, 2 & 3 are shorted together, and pins 4, 5 & 6 are shorted together.

\*2 For 10 seconds.



LIGHTING FOREVER

# 8 PIN SOP PHOTOTRANSISTOR DUAL CHANNEL PHOTOCOUPLER

## ELD20X / 21X series

### Electrical Characteristics (T<sub>a</sub>=25°C unless specified otherwise)

#### Input

Parameter	Symbol	Min.	Typ.*	Max.	Unit	Condition
Forward voltage	V <sub>F</sub>	-	1.2	1.5	V	I <sub>F</sub> = 10mA
Reverse current	I <sub>R</sub>	-	0.1	100	μA	V <sub>R</sub> = 6V
Input capacitance	C <sub>in</sub>	-	25	-	pF	V = 0, f = 1MHz

#### Output

Parameter	Symbol	Min.	Typ.*	Max.	Unit	Condition
Collector-Emitter dark current	I <sub>CEO</sub>	-	5.0	50	nA	V <sub>CE</sub> = 10V, I <sub>F</sub> = 0mA
Collector-Emitter breakdown voltage	BV <sub>CEO</sub>	80	-	-	V	I <sub>C</sub> = 0.1mA
Emitter-Collector breakdown voltage	BV <sub>ECO</sub>	7	-	-	V	I <sub>E</sub> = 0.1mA
Collector-Emitter capacitance	C <sub>CE</sub>	-	10	-	pF	V <sub>CE</sub> = 0V, f = 1MHz

#### Transfer Characteristics

Parameter	Symbol	Min.	Typ.*	Max.	Unit	Condition
Current Transfer Ratio	ELD205	40	-	80	%	I <sub>F</sub> = 10mA, V <sub>CE</sub> = 5V
	ELD206	63	-	125		
	ELD207	100	-	200		
	ELD211	20	-	-		
	ELD213	100	-	-		
Current Transfer Ratio	ELD205	13	30	-	%	I <sub>F</sub> = 1mA, V <sub>CE</sub> = 5V
	ELD206	22	45	-		
	ELD207	34	70	-		
	ELD217	100	120	-		
Collector-emitter saturation voltage	V <sub>CE(sat)</sub>	-	-	0.4	V	I <sub>F</sub> = 10mA, I <sub>C</sub> = 2.5mA
Isolation resistance	R <sub>IO</sub>	-	10 <sup>11</sup>	-	Ω	V <sub>IO</sub> = 500Vdc
Input-output capacitance	C <sub>IO</sub>	-	0.5	-	pF	V <sub>IO</sub> = 0, f = 1MHz
Turn-on time	T <sub>on</sub>	-	5.0	-	μs	V <sub>CC</sub> = 5V, I <sub>C</sub> = 2mA, R <sub>L</sub> = 100Ω
Turn-off time	T <sub>off</sub>	-	4.0	-		
Rise time	T <sub>r</sub>	-	1.6	-		
Fall time	T <sub>f</sub>	-	2.2	-		

\* Typical values at T<sub>a</sub> = 25°C

# 8 PIN SOP PHOTOTRANSISTOR DUAL CHANNEL PHOTOCOUPLER

## ELD20X / 21X series

### Typical Performance Curves

Figure 1. Forward Current vs Forward Voltage

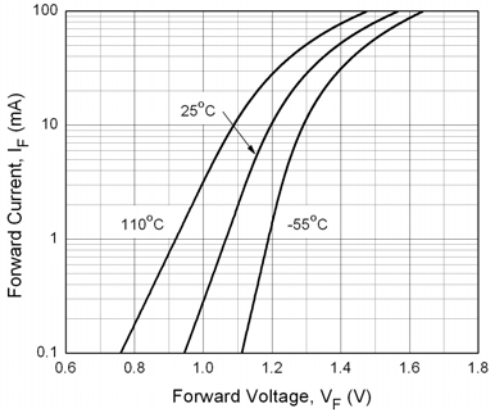

Figure 2. Normalized Collector Current vs. Forward Current

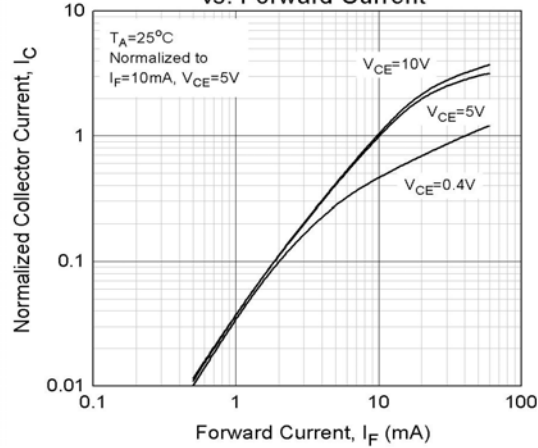

Figure 3. Normalized Collector Current vs Ambient Temperature

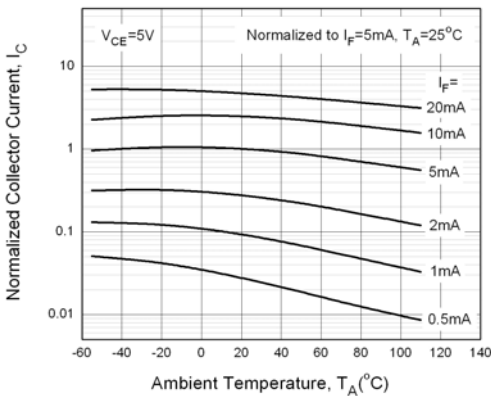

Figure 4. Collector Dark Current vs Ambient Temperature

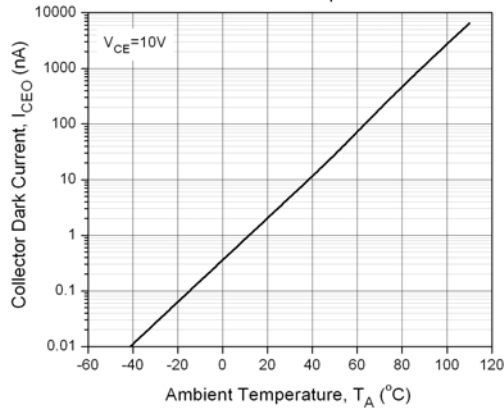

Figure 5. Collector Current vs Collector-Emitter Voltage

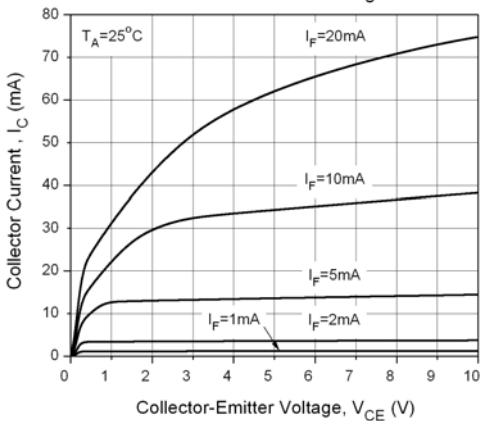
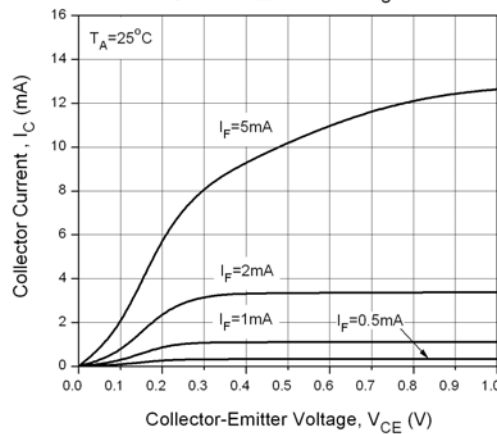

Figure 6. Collector Current vs Collector-Emitter Voltage



# 8 PIN SOP PHOTOTRANSISTOR DUAL CHANNEL PHOTOCOUPLER

ELD20X / 21X series

Figure 7. Turn-on, Turn-off Times vs. Load Resistance

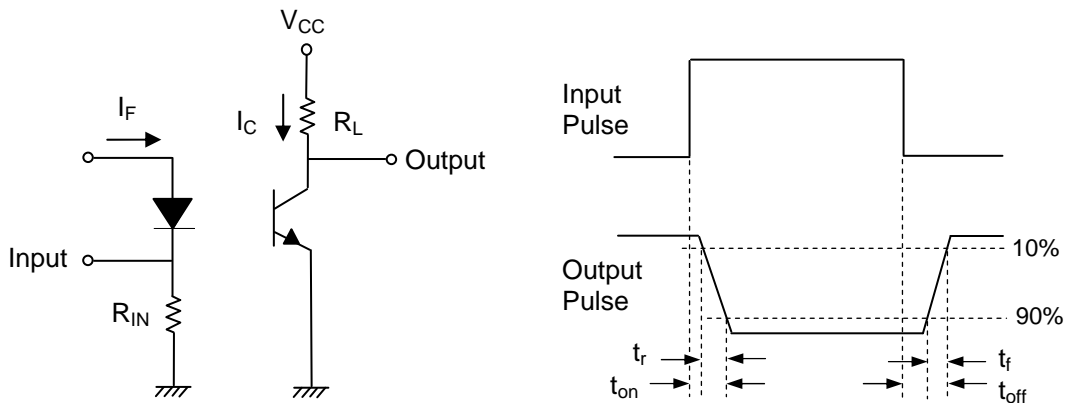
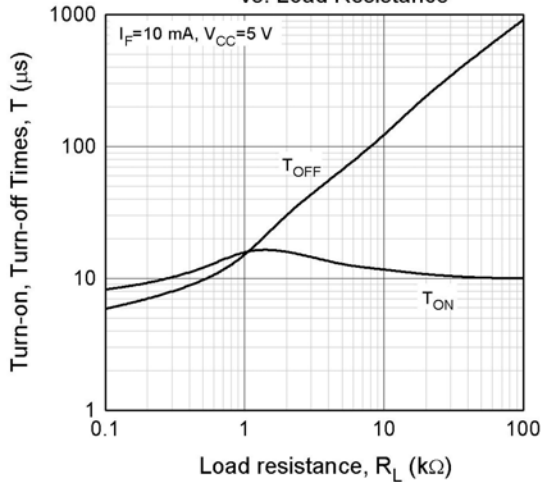

Figure 7. Switching Time Test Circuit & Waveforms



LIGHTING FOREVER

# 8 PIN SOP PHOTOTRANSISTOR DUAL CHANNEL PHOTOCOUPLER

## ELD20X / 21X series

---

### Order Information

Part Number

# ELD2XX(Y)

Note

X X= Part no. (05, 06, 07, 11, 13 or 17)

Y = Tape and reel option (TA, TB or none).

Option	Description	Packing quantity
None	Standard	100 units per tube
(TA)	TA tape & reel option	2000 units per reel
(TB)	TB tape & reel option	2000 units per reel



LIGHTING FOREVER

# 8 PIN SOP PHOTOTRANSISTOR DUAL CHANNEL PHOTOCOUPLER

## ELD20X / 21X series

### Package Drawings (Dimensions in mm)

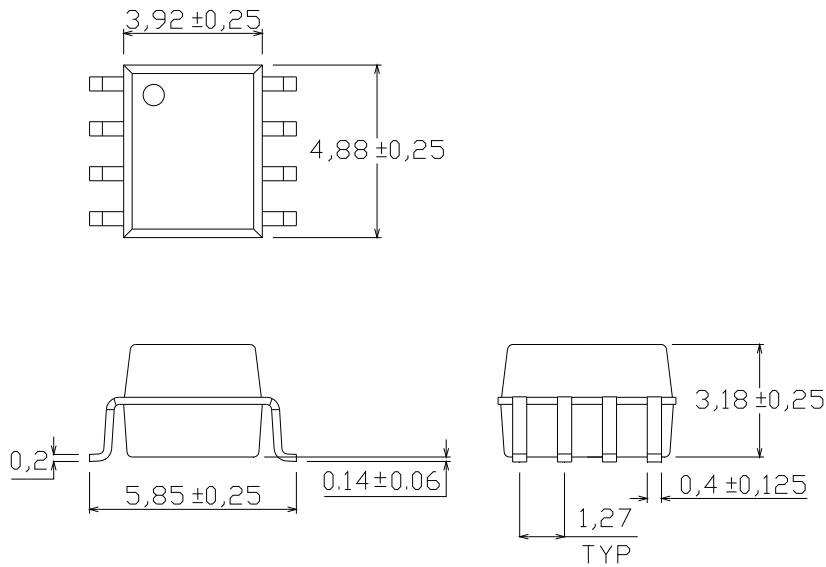

### Recommended pad layout for surface mount leadform

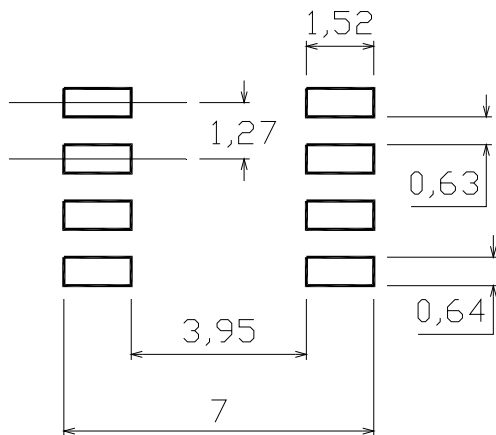



LIGHTING FOREVER

# 8 PIN SOP PHOTOTRANSISTOR DUAL CHANNEL PHOTOCOUPLER

## ELD20X / 21X series

### Device Marking

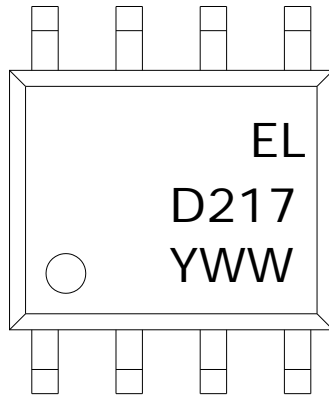

### Notes

EL	denotes Everlight
217	denotes Part Number
Y	denotes 1 digit Year code
WW	denotes 2 digit Week code





LIGHTING FOREVER

# 8 PIN SOP PHOTOTRANSISTOR DUAL CHANNEL PHOTOCOUPLER

ELD20X / 21X series

## Tape & Reel Packing Specifications

### Option TA

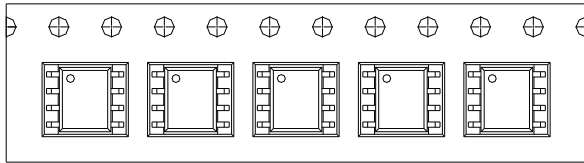

### Option TB

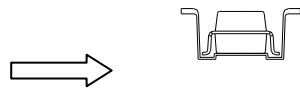
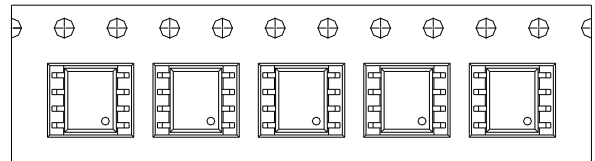

Direction of feed from reel



Direction of feed from reel

## Tape dimensions

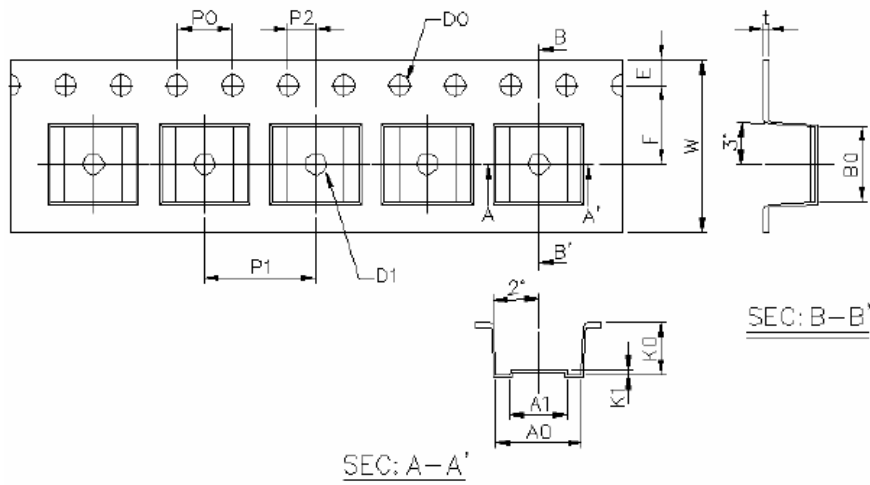

Dimension No.	<b>A0</b>	<b>A1</b>	<b>B0</b>	<b>D0</b>	<b>D1</b>	<b>E</b>	<b>F</b>
Dimension(mm)	6.2±0.1	4.1±0.1	5.28±0.1	1.5±0.1	1.5±0.3	1.75±0.1	5.5±0.1
Dimension No.	<b>Po</b>	<b>P1</b>	<b>P2</b>	<b>t</b>	<b>W</b>	<b>K0</b>	<b>K1</b>
Dimension(mm)	4.0±0.1	8.0±0.1	2.0±0.1	0.4±0.1	12.0+0.3/ -0.1	3.7±0.1	0.3±0.1



LIGHTING FOREVER

# 8 PIN SOP PHOTOTRANSISTOR DUAL CHANNEL PHOTOCOUPLER

## ELD20X / 21X series

### Solder Reflow Temperature Profile

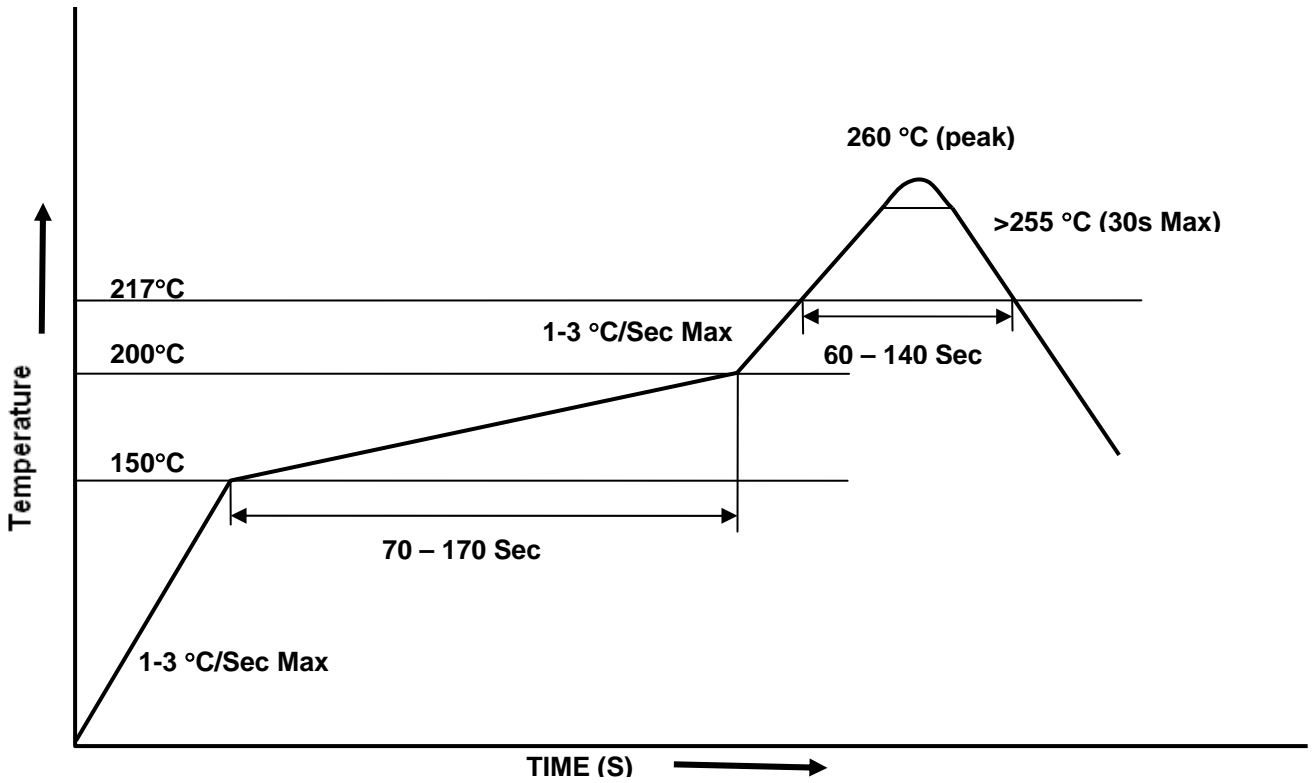



# 8 PIN SOP PHOTOTRANSISTOR DUAL CHANNEL PHOTOCOUPLER

**ELD20X / 21X series**

---

## DISCLAIMER

1. The specifications in this datasheet may be changed without notice. EVERLIGHT reserves the authority on material change for above specification.
2. When using this product, please observe the absolute maximum ratings and the instructions for use as outlined in this datasheet. EVERLIGHT assumes no responsibility for any damage resulting from use of the product which does not comply with the absolute maximum ratings and the instructions included in this datasheet.
3. These specification sheets include materials protected under copyright of EVERLIGHT. Reproduction in any form is prohibited without the specific consent of EVERLIGHT.